

PRODUCT SPECIFICATION DRAWING

HOLDRITE® FLAME FIGHTER™ #424-S, #425-S & #426-S Inserts (25/50 Plenum Rated)

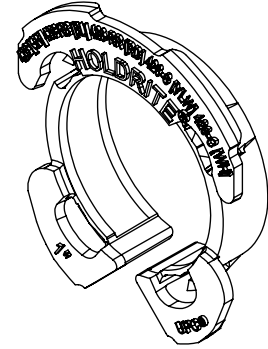

ALL DIMENSIONS IN INCHES

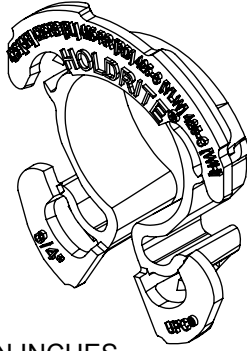
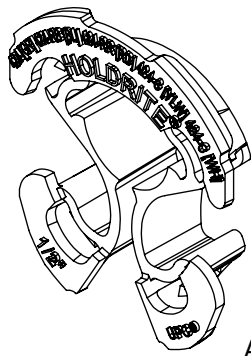
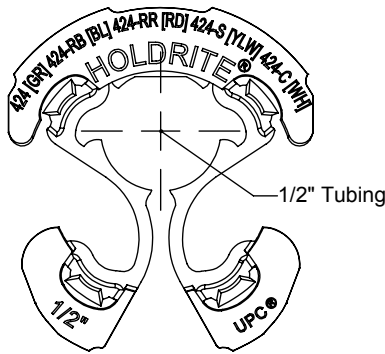
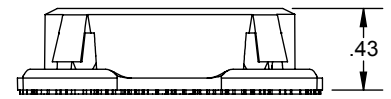
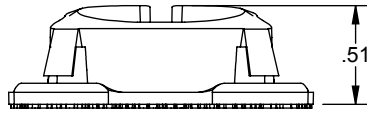
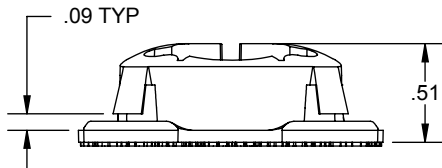

#424-S

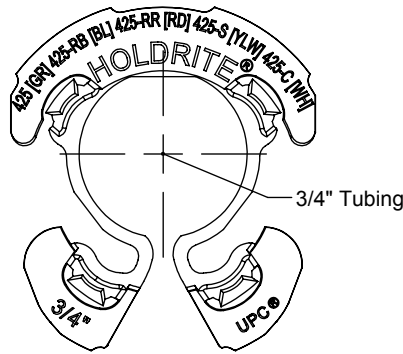

#425-S

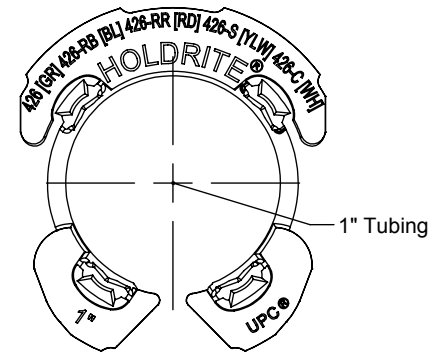

#426-S

For used with 1-11/32" or 1-3/8" round cut-outs in 14 to 25 gage sheet metal. Ideal for isolation of Copper, PEX or CPVC tubing. Material meets ASTM E-84 25/50 and UL94V-0 fire rating.

Product Information:

- Material: Kynar Flex, Yellow, UL94V-0
- Temperature range: -20 °F to 200 °F
- Meets ASTM E-84 25/50 and UL94V-0
- UPC / IPC / IAPMO listed



THIS INFORMATION IS PROPRIETARY TO HUBBARD ENTERPRISES AND IS SUBJECT TO CHANGE WITHOUT NOTICE. ANY REPRODUCTION IN PART OR WHOLE WITHOUT THE WRITTEN PERMISSION OF HUBBARD ENTERPRISES IS PROHIBITED.

.....HUBBARD ENTERPRISES.....
HOLDRITE®
 "Converting Makeshift Methods into Engineered Solutions"

Product Submittal	
Job Name:	
Date:	
Part Number:	Qty:
Architect / Owner:	
Contractor:	
Notes:	